

7.40 MIDDLE FS

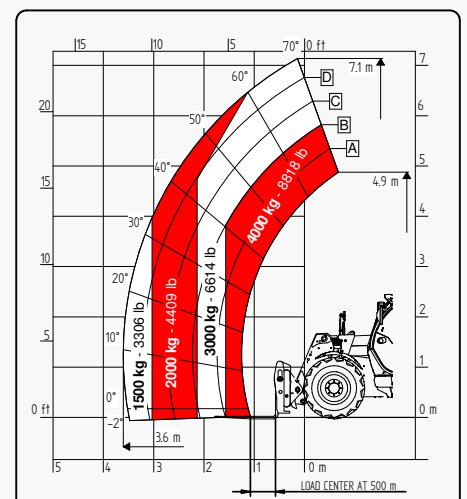

It brings to the attention of all potential customers, all recipients, and to the maximum extent possible, external interlocutors, that Faresin Industries S.p.A. adopts a general Disclaimer regarding the description of the technical and functional characteristics of its machineries, as well as the manner of their use, also with regard to their safety. The Disclaimer must be understood as having a general scope, and therefore Faresin Industries s.p.a. invites to know it, also by accessing the website: www.faresindustries.com

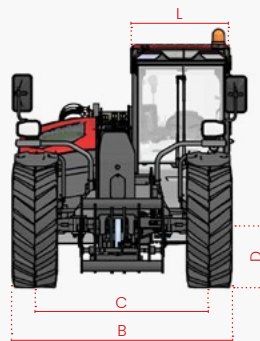
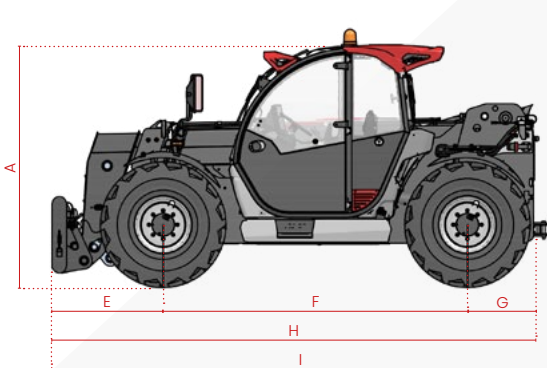

FARESIN.COM



7.40 MIDDLE FS

TECHNICAL FEATURES

MODELS		7.40
DIMENSIONS		
[A] Height	mm	2.450
[B] Width	mm	2.310
[C] Track	mm	1.862
[D] Ground clearance	mm	350
[E] Front overhang	mm	1.007
[F] Pitch	mm	2.950
[G] Rear overhang	mm	804
[H] Length without tow hook	mm	4.761
[I] Length with tow hook	mm	4.922
[L] Cab width	mm	960
WEIGHT		
CLASSIC 55	kg	-
CLASSIC 75	kg	-
DYNAMIC 85	kg	-
PERFORMANCE 85	kg	-
EXCELLENCE 85	kg	-
EXCELLENCE HVTRONIC 100	kg	-

MODELS		7.40
DETAILS		
Number of retracting sections	nr	1
Max flow rate	kg	4.000
Max lifting height	m	7,1
Horizontal max outreach	m	3,6
Outreach at max height	m	0,2
Swinging angle	°	144
TANK CAPACITY		
Hydraulic oil tank	l	120
Diesel tank	l	120

NOTE: Dimensions defined on Dynamic version with 20" wheels

● Standard ○ Optional - Not available

INSTALLATIONS	CLASSIC 55	CLASSIC 75	DYNAMIC 85	PERFORMANCE 85	EXCELLENCE 85	EXCELLENCE HVTRONIC 100
TRANSMISSION						
Hydrostatic	single gear	single gear	single gear	2 mechanical gears	2 mechanical gears	continuous variation
Speed	km/h	25	30	30	40	40
ENGINE STAGE V						
Manufactured	Deutz	Deutz	Deutz	Deutz	Deutz	Deutz
Power	kW/hp	55,4/75	75/102	85/115	85/115	100/136
Post-treatment system	DOC + DPF	DOC + DPF + SCR	DOC + DPF + SCR	DOC + DPF + SCR	DOC + DPF + SCR	DOC + DPF + SCR
Pulling force	daN	5.100	5.100	5.100	5.890	10.000
HYDRAULICS						
Pump type	gears	gears	gears	LS piston	LS piston	LS piston
Distributor	flow sharing	flow sharing	flow sharing	flow sharing	flow sharing	flow sharing
Hydraulic flow-rate	l/bar	100/250	100/250	120/250	150/250	170/250
WHEELS						
400/70 20	●	●	●	○	○	○
405/70 24	○	○	○	●	●	●
Steering radius	m	4	4	4	4,15	4,15
VARIOUS						
Joystick	electro-hydraulic proportional	electro-hydraulic proportional	electro-hydraulic proportional	electro-hydraulic proportional	CAN-BUS electro proportional	CAN-BUS electro proportional
Quick coupling	○	○	○	○	●	●
Rear hydraulic connection	○	○	○	●	●	●
LED front lights	○	○	○	○	●	●
LED rear lights	●	●	●	●	●	●
LED front and rear work lights	○	○	○	●	●	●
Trailer lights rear socket	○	○	●	●	●	●
Fixed tow hook 12 t	○	○	●	●	●	●
Engine water preheating	○	○	○	○	○	○
Air conditioning	○	○	○	○	●	●
Ecofast Valve	N/D	N/D	N/D	●	●	●
Floating boom	○	○	○	○	●	●
Boom suspension	○	○	○	○	○	○
Manual 6-way diverter valve	○	○	○	○	●	●
BES (Boom Electric Socket)	○	○	○	○	○	○
Creeper	●	●	●	●	●	●
Constant front flow	●	●	●	●	●	●
Bucket mode	●	●	●	●	●	●
Radiator fan	proportional non-reversible	proportional non-reversible	proportional non-reversible	proportional reversible	proportional reversible	proportional reversible