

**KENMERKEN / FEATURES / MARKMALE**

	Q-135EL18	Q-135EL24
H (max.)	± 15,50 m	± 15,50 m
A (max.)	± 13,50 m	± 13,50 m
C (min.)	± 1,82 m	± 1,86 m
DxF (min.)	4,26 x 1,78 m	4,26 x 2,30 m
ExF (max.)	6,06 x 1,78 m	6,06 x 2,30 m
H1	3,00 m	3,06 m
H3	2,25 m	2,30 m
LxB	4,64 x 1,80 m	4,64 x 2,39 m
G	3,08 m	3,08 m
M	124 mm	180 mm
Ø D	± 4,34 m	± 4,70 m
(max.)	750 kg (2 pers. + 590kg)	750 kg (2 pers. + 590kg)
(max.)	750 kg (2 pers. + 590kg)	750 kg (2 pers. + 590kg)
(sec.)	63/44 sec.	65/42 sec.
	2,3 km/h	2,3 km/h
	0,5 km/h	0,5 km/h
	28 x 9 - 15	--
--	--	31 x 12,5 x 15
--	--	--
(max.)	± 25%	± 25%
	400 Ah/5/48 V	400 Ah/5/48 V
	7.390 kg	7.590 kg

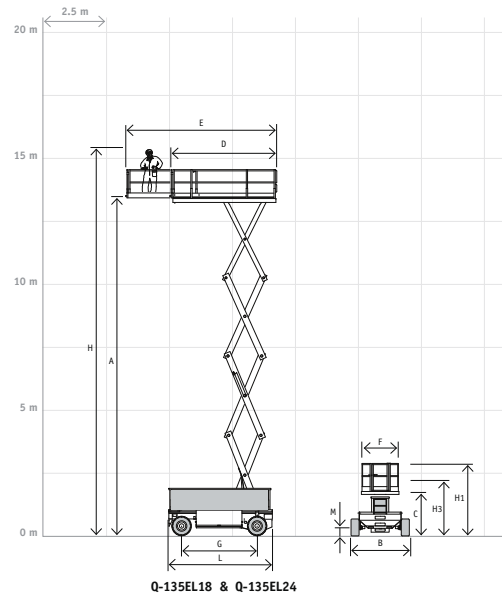













NEDERLANDS	ENGLISH	DEUTSCH		
<b>OPTIES</b>	<b>OPTIONS</b>	<b>OPTIONEN</b>		
Besturing met snelsluitstekker	Controlbox with quick disconnect	Plattformsteuerung mit Schnellstecker		
Urenteller	Hourmeter	Stundenzähler		
Lader (hoogfrequent)	Charger (high frequency)	Ladegerät (Hochfrequenz)		
230V voorziening op het platform	230V supply on the platform	230V Versorgung an der Plattform		
Rijden op volle hoogte	Driving at full height	Fahren in voller Höhe	--	
Rijden, proportioneel	Driving, proportional	Fahren, proportional		
Sperfunctie	Differential lock	Differentialsperre		
Smeersysteem (Easy Lube, Auto Lube)	Lubrication system (Easy Lube, Auto Lube)	Schmierstystem (Easy Lube, Auto Lube)		
<b>VEILIGHEIDSVORZIENINGEN</b>	<b>SAFETY FEATURES</b>	<b>SICHERHEITSEINRICHTUNGEN</b>		
Beschermhek	Scissor skirt	Schutzgitter		
Daalbeveiliging	Descent safety	Senkschutz	--	--
Rij-alarm (akoestisch)	Drive alarm	Fahrwarnung (akustisch)		
Nooddalvoorziening	Emergency descent	Notsenkvorrichtung		
<b>TOEPASSING</b>	<b>APPLICATION</b>	<b>ANWENDUNG</b>		
Voor gebruik in gesloten ruimten	Indoors	In geschlossenen Räumen		
Voor gebruik buiten	Outdoors	Im Freien	--	
Toelaatbare min. omgevingstemperatuur	Certified min. temperature	Zul. Tiefsttemperatur	-15°C	-15°C

**NOTITIES / NOTES / NOTIZEN**



Holland Lift International B.V.

Anodeweg 1 Tel: +31 (0) 229 285555  
 NL-1627 LJ Hoorn Fax: +31 (0) 229 285550  
 The Netherlands E-mail: info@hollandlift.com

H (max.)	Werkhoogte Working height Arbeitshöhe
A (max.)	Max. platformhoogte Max. platform height Max. Plattformhöhe
C (min.)	Min. platformhoogte Min. platform height Min. Plattformhöhe
DxF (min.)	Platform afmetingen (ingeschoven) Platform dimensions (retracted) Plattformgröße (eingeschoben)
ExF (max.)	Platform afmetingen (uitgeschoven) Platform dimensions (extended) Plattformgröße (ausgeschoben)
H1	Transporthoogte Transport height Transporthöhe
H2	Transporthoogte (handrail verwijderd) Transport height (handrail removed) Transporthöhe (Geländer entfernt)
H3	Transporthoogte (handrail neergeklapt) Transport height (handrail folded down) Transporthöhe (Geländer umgeklappt)
LxB	Transportafmetingen Transport dimensions Transportabmessungen
G	Wielbasis Wheel base Radstand
K	Trackbreedte Track width Raupenbreite
M/N	Bodemvrijheid Ground clearance Bodenfreiheit
Ø D	Draaicirkel uitwendig Turning radius outside Wendradius Außen
 (max.)	Max. belasting platform (ingeschoven) Capacity main platform Tragfähigkeit Plattformfestteil
 (max.)	Max. belasting platform (uitgeschoven) Capacity roll-out deck Tragfähigkeit Plattformausschub
 (sec.)	Hef-/daaltijd (max. last) Lift-/lower time (max. load) Hebe-/Senkzeit (max. Traglast)
	Rijsnelheid (snel) Driving speed (high) Fahrgeschwindigkeit (schnell)
	Rijsnelheid (langzaam) Driving speed (slow) Fahrgeschwindigkeit (langsam)
	Banden, non marking (volrubber) Tyres, non marking (solid rubber) Reifen, non marking (Vollgummi)
	Banden, terrein (schuimgevoeld) Tyres, terrain (foamfilled) Reifen, Gelände (ausgeschäumt)
	Banden, tractor (schuimgevoeld) Tyres, tractor (foamfilled) Reifen, Traktor (ausgeschäumt)
	Vlakstellen links/rechts (dwars) Leveling left/right (transversal) Quernivellament (links/rechts)
 (max.)	Max. klimvermogen Gradeability Max. Steigfähigkeit
	Batterijcapaciteit (natte cellen) Batteries (traction acid) Batteriekapazität (Traktion Naßzellen)
	Dieselmotor Diesel engine Dieselmotor
 KG	Eigengewicht Gross weight Eigengewicht
	Standaard Standard Standardausrüstung
	Optie Option Option
--	Niet beschikbaar Not available Nicht verfügbar